

Eaton SB200403TG

Catalog Number: SB200403TG

Eaton auxiliary support tube, Steel, Pre-assembled tube, spacer and hardware included, Used as an auxiliary support, 3" length, Telco gray powder coat, 2" X 9/16" Support tube

General specifications

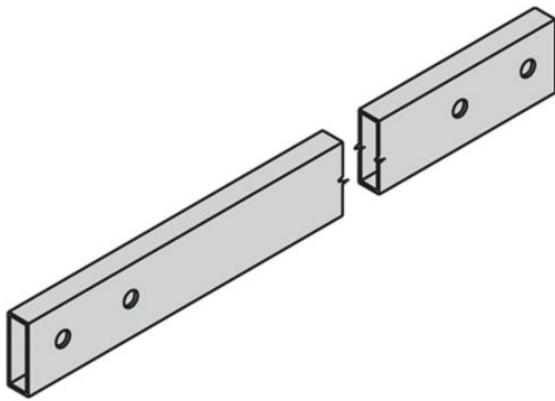

Product Name	Catalog Number
Eaton auxiliary support tube	SB200403TG
UPC	Product Length/Depth
799038015376	3 in
Product Height	Product Width
2 in	0.5625 in
Product Weight	Certifications
3 lb	Not Applicable

Product specifications

Model

2" X 9/16" support tube

Material

Steel

Finish

Telco gray powder coat

Resources

Catalogs

[auxillary supports](#)

Specifications and datasheets

[Eaton Specification Sheet - SB200403TG](#)



Eaton Corporation plc
Eaton House
30 Pembroke Road
Dublin 4, Ireland
Eaton.com
© 2023 Eaton. All Rights Reserved.

Eaton is a registered trademark.

All other trademarks are property of their respective owners.



[Eaton.com/socialmedia](https://www.eaton.com/socialmedia)